

# PLANS TECHNIQUE ET RESERVATION PORTE ALUMINIUM 60 mm

## SOMMAIRE

Plan de réservation .....	<b>17</b>
Planche profils .....	<b>18</b>
Dormant standard aile de 15 mm	
Pose en applique intérieure .....	<b>19</b>
Pose en applique intérieure avec iso 120 mm .....	<b>19</b>
Coupes sur fixe et imposte en dormant, avec iso 120 mm .....	<b>20</b>
Dormant double rainure avec cornière 10x30, dépose totale .....	<b>21</b>
Dormant double rainure, pose en tunnel .....	<b>21</b>
Dormant à recouvrement 60 mm, pose sur dormant existant .....	<b>22</b>
Dormant à recouvrement 60 mm, dépose totale iso 120 mm .....	<b>22</b>
Dormant double rainure, ouverture 90° .....	<b>23</b>

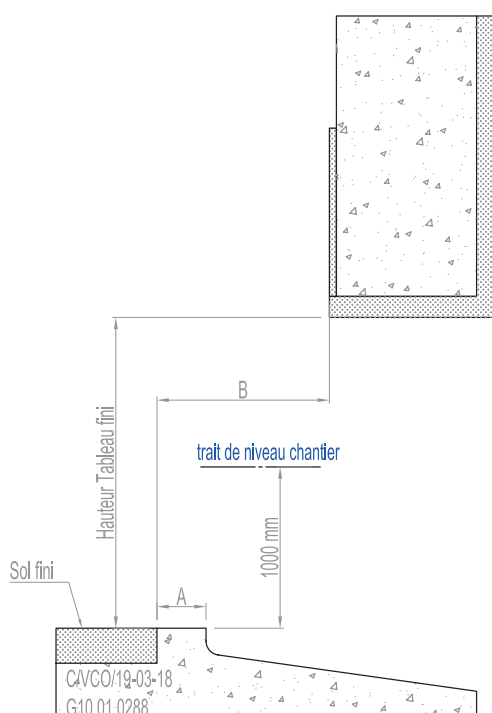

## PLAN DE RÉSERVATION

ÉPAISSEUR D'ISOLATION	CÔTES EN MM	
	A	B
60	52	60
80	52	80
100	52	100
120	52	120
140	52	140
160	52	160
180	52	180
200	52	200

# Planche profils

## Gamme ALU 60

### Tapée

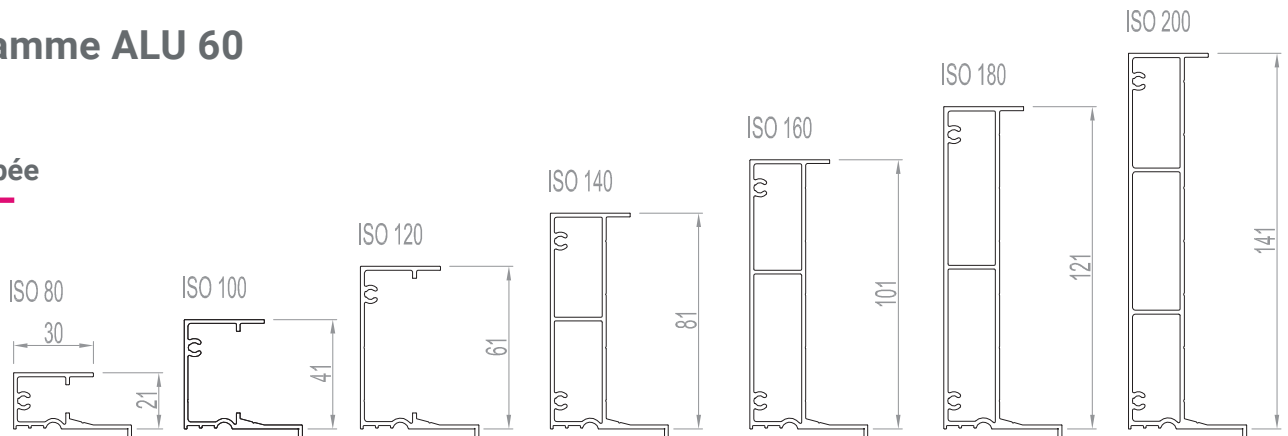

### Dormant standard

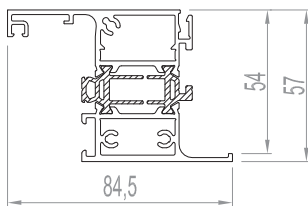

### Meneau

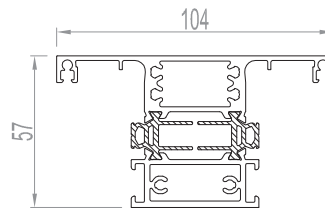

### Traverse intermédiaire

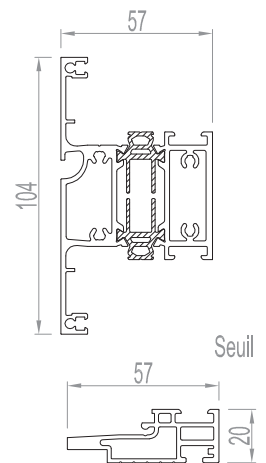

### Dormant double rainure

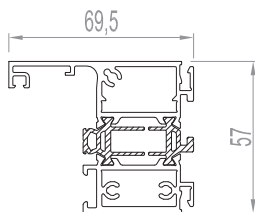

### Habillages

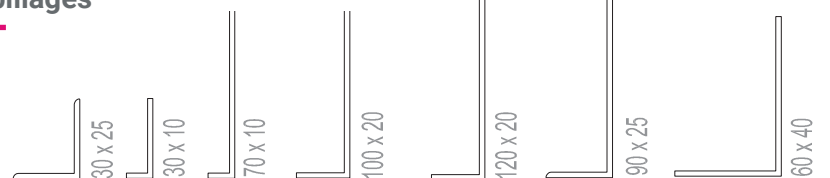

### Dormant à recouvrement

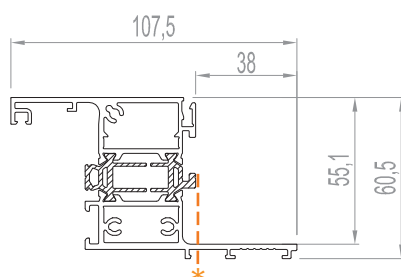

### Moultre contemporaine



### Moultre classique



# Dormant standard aile de 15 mm

## Gamme ALU 60

### Pose en applique intérieure sans tapée

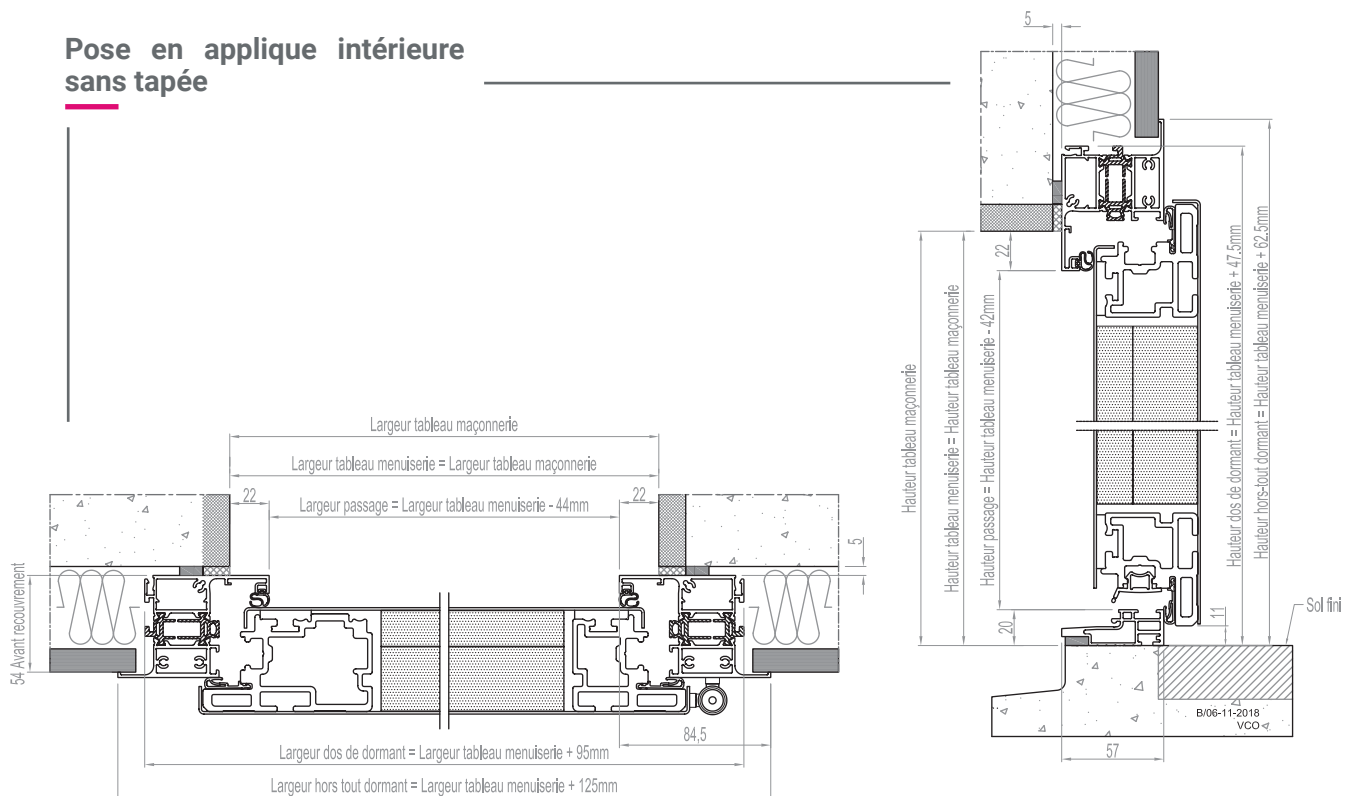

### Pose en applique intérieure avec iso 120 mm

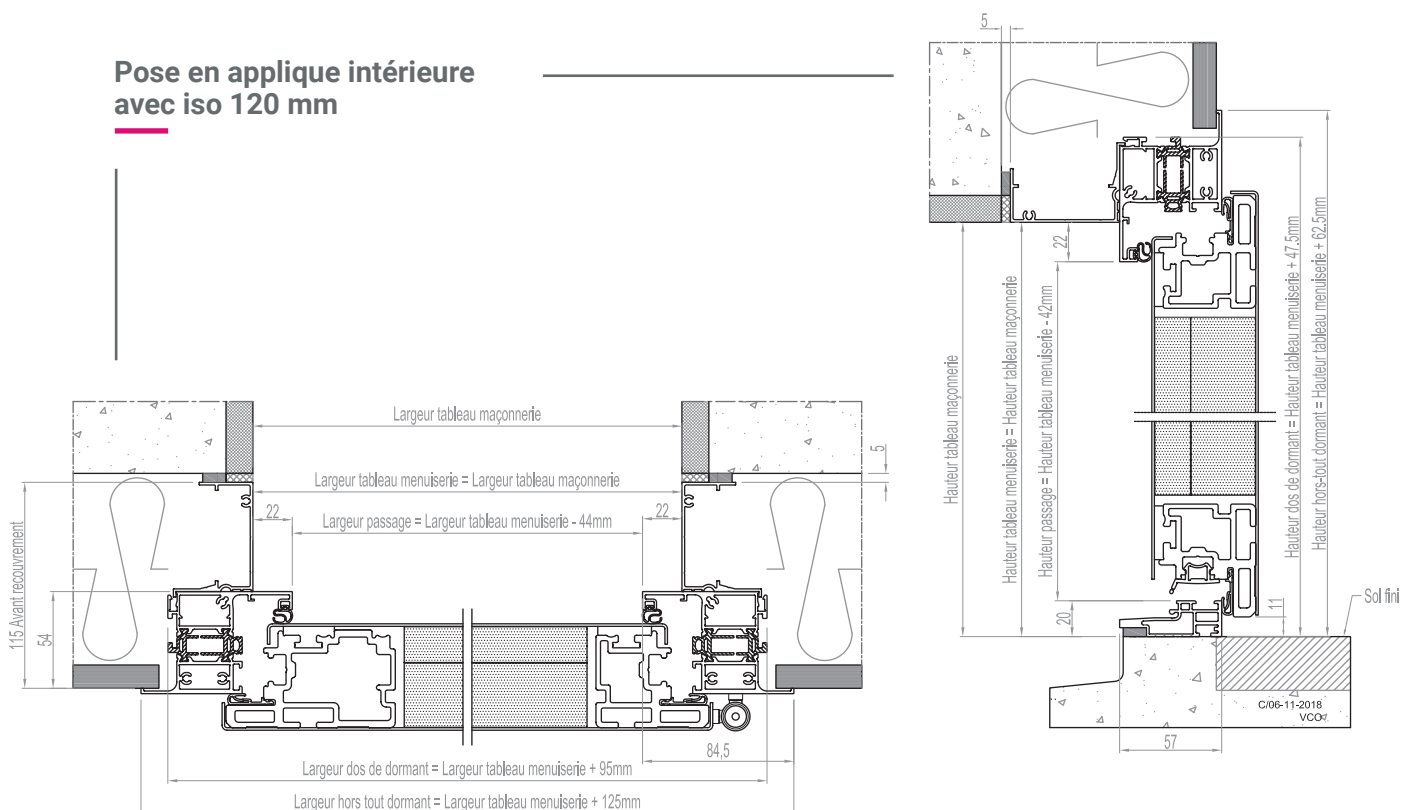

# Dormant standard iso 120 mm

## Gamme ALU 60

### Coupe horizontale sur fixe en dormant

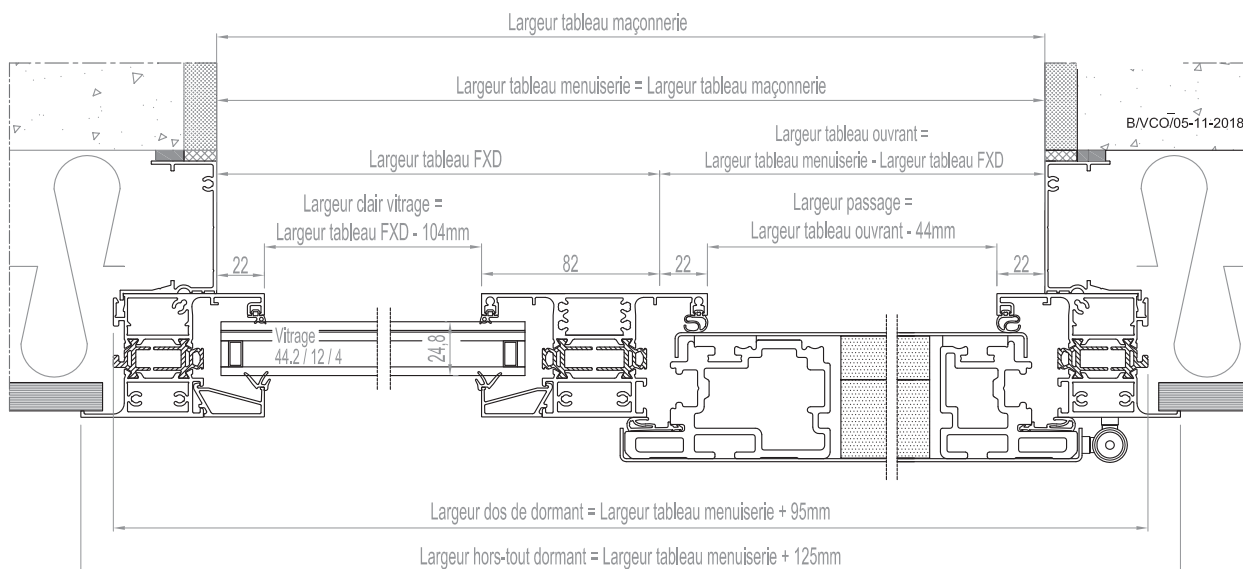

### Coupe verticale sur fixe en dormant

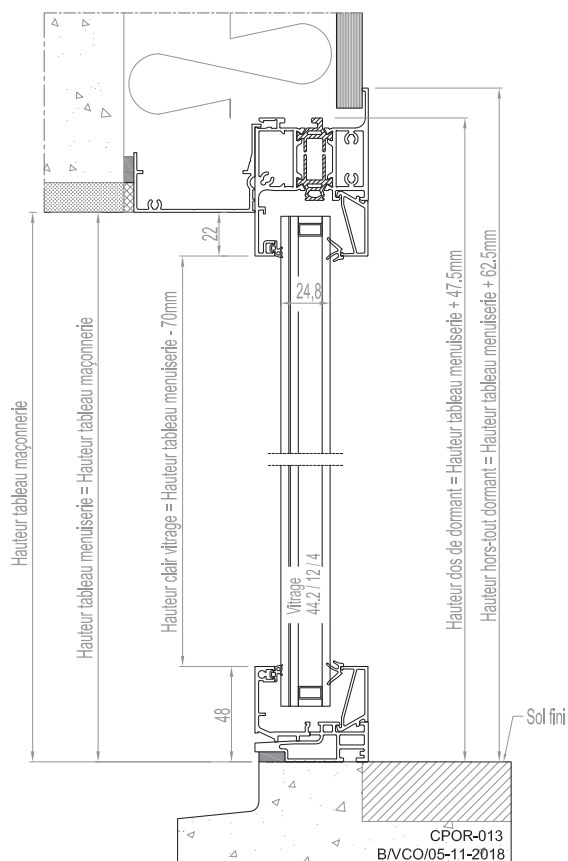

### Coupe verticale sur imposte

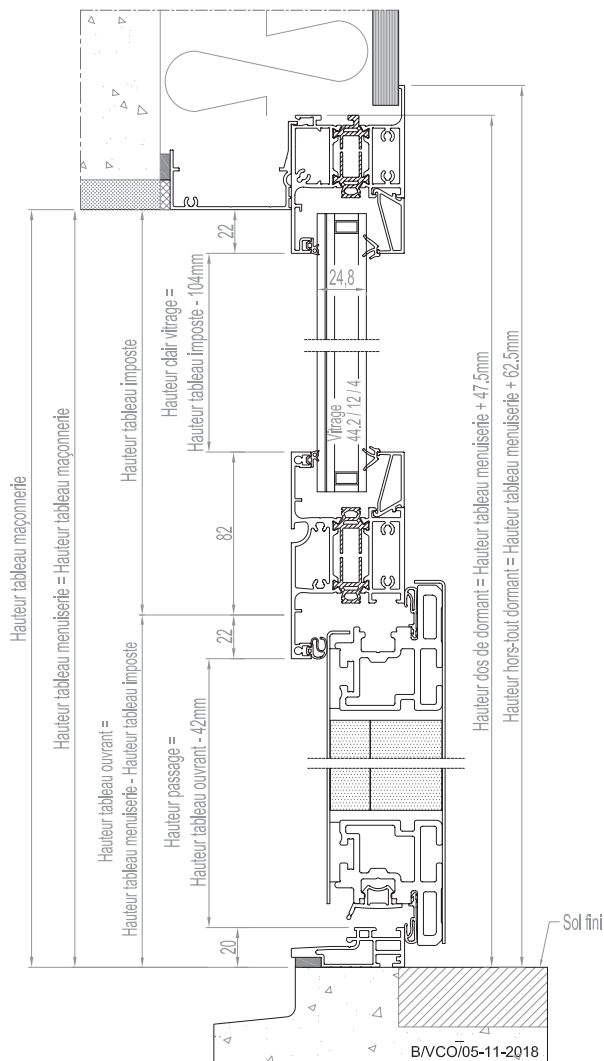

# Dormant double rainure

Gamme ALU 60

**Avec cornière d'habillage 10x30 mm**  
**Dépose totale**

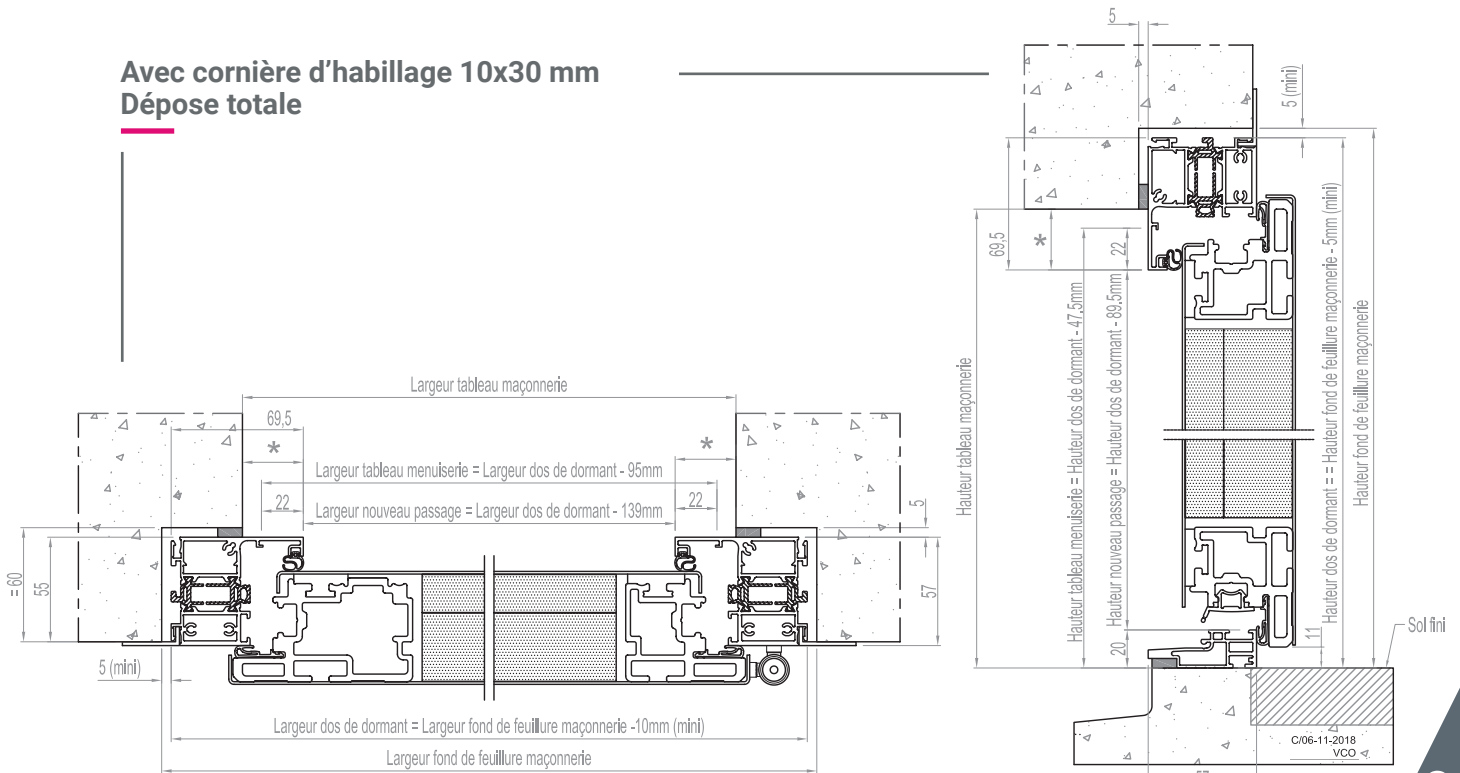

\* Cochonnet théorique de 22mm, variable de 0 à 52mm

Largeur dos de dormant = Largeur hors tout dormant  
Hauteur dos de dormant = Hauteur hors tout dormant

**Pose en tunnel**

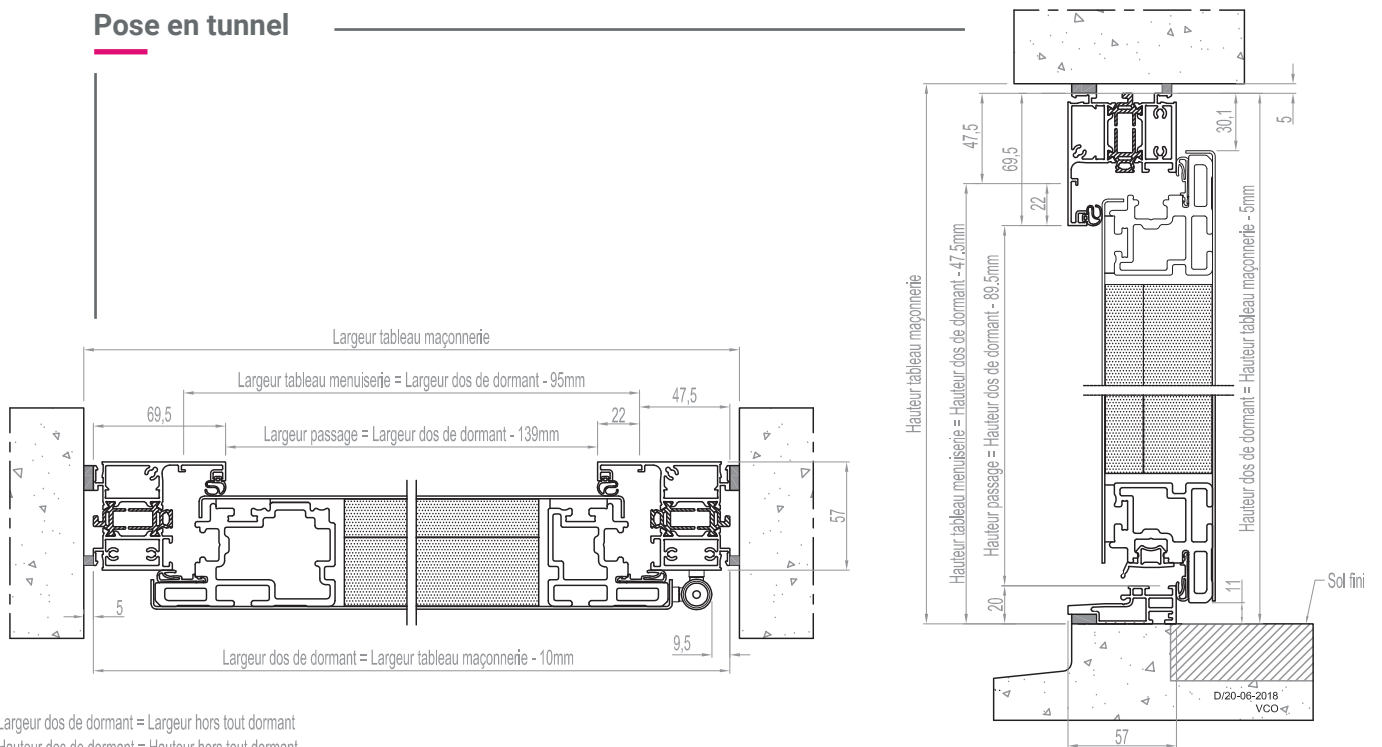

Largeur dos de dormant = Largeur hors tout dormant  
Hauteur dos de dormant = Hauteur hors tout dormant

# Dormant à recouvrement 60 mm (option 40 mm)

## Gamme ALU 60

### Pose sur dormant existant

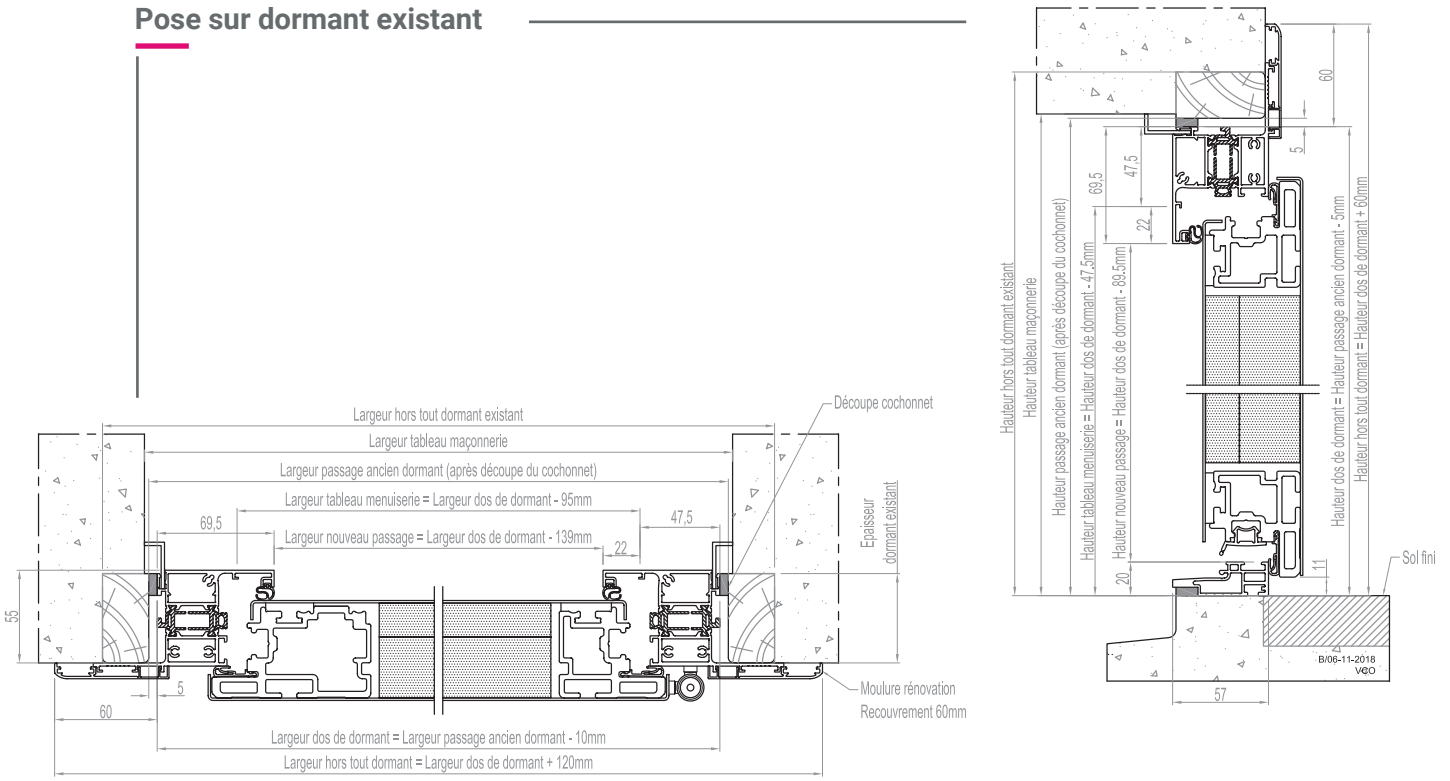

22

# Dormant à recouvrement 60 mm (option 40 mm)

## Gamme ALU 60

### Dépose totale iso 120 mm

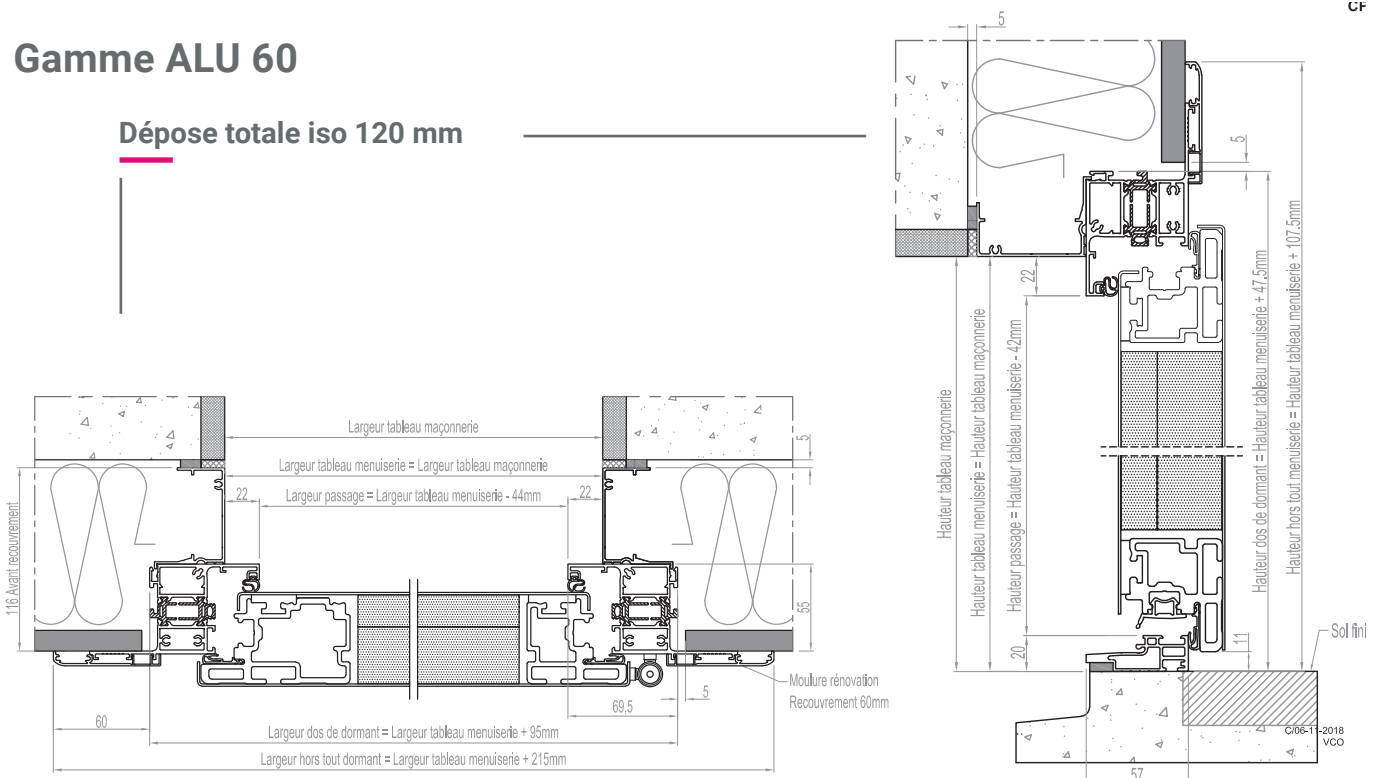

CF

# Dormant double rainure

## Gamme ALU 60

### Ouverture à 90°

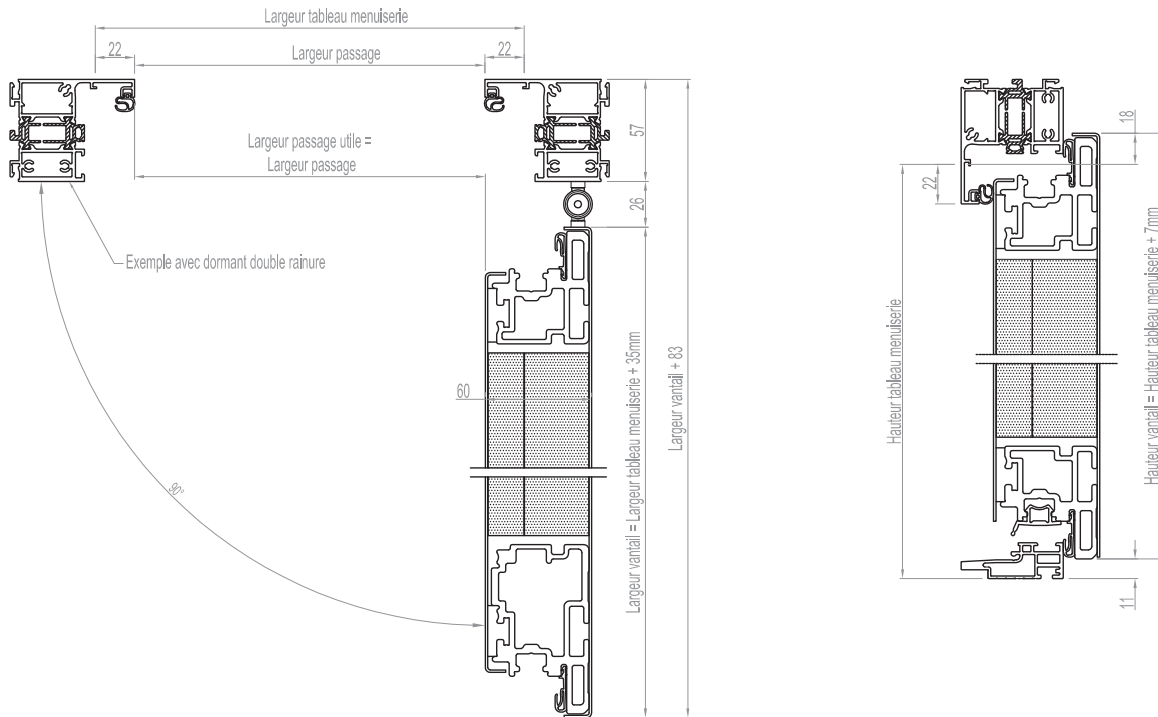

E/15-11-2018  
VCO

## NOTES

.....

.....

.....

.....

.....

.....

.....

.....

.....

.....

.....

.....

.....

.....

.....

.....

.....

.....

.....

.....

.....

.....

.....

.....

.....